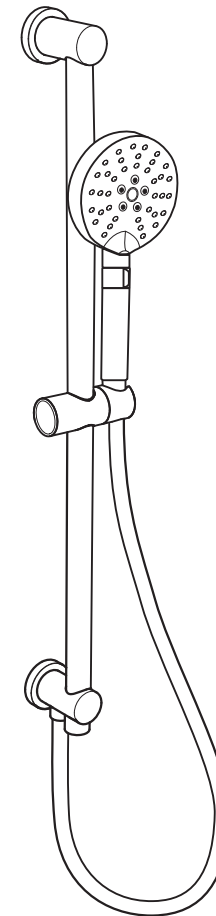

**WARRANTY**

PARISI has confidence in their products' quality and function and offer lengthy and comprehensive warranties against manufacturing defects, which are in addition to that required under Australian Consumer Law.

Refer to our website for full warranty terms and conditions:

[www.parisi.com.au/pages/warranty-information](http://www.parisi.com.au/pages/warranty-information)

**ENVY II SLIDING RAIL WITH BUTTON SLIDER  
AND HANDSHOWER****P1.SR**

## ENVY II SLIDING RAIL WITH BUTTON SLIDER AND HANDSHOWER INSTALLATION

Begin installation by unscrewing grub screws to remove female adaptor and wall bracket from assembly.

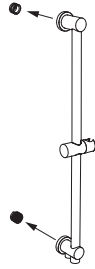

BOTTOM INLET (Default)

A

Drill hole for wall plug vertically aligned 685mm from wall outlet. Fit plug, and screw wall bracket into location.

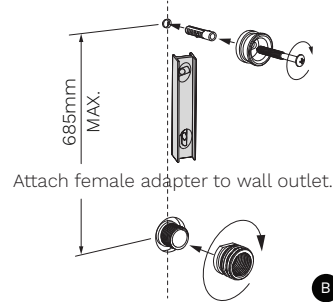

Attach female adaptor to wall outlet.

B

Attach rail to wall and tighten grub screws to fix rail on position.

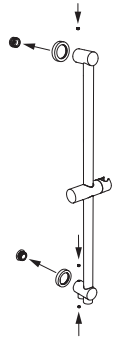

C

Attach hose and handshower.

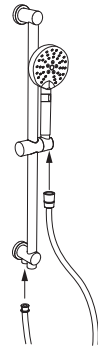

D

If Top Inlet is required, remove wall elbow and handshower holder. Invert rail and re-assemble wall elbow and handshower holder.

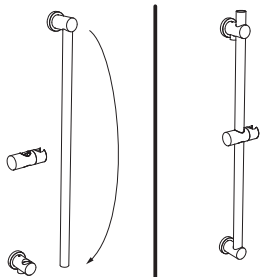

E

Repeat steps B, C and D to install and fix to wall.

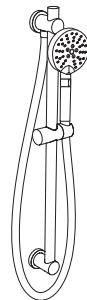

TOP INLET (Optional)

F

## WARNING



1. Each tapware body/shower assembly is hydraulically pressure tested at the factory. Do not attempt to dismantle the assembly yourself.



2. Before installing the tapware, flush out the water lines to ensure that the pipes are free of any dirt or debris: avoid blockages in the cartridges.



3. After installing the tapware, check all connection points for leakages. Always turn OFF water before removing or disassembling the tapware.



4. Hydraulic pressure for Parisi tapware is 50-500 kPa (including hot and cold hydraulic pressure).



5. Open tapware handle to relieve water pressure and ensure that the water is shut off completely.



6. Do not apply any undue force when using any tools.



7. Do not bend or squeeze the hoses.



8. Max working temperature is 80°C.

## CLEANING

Constant or regular cleaning will maintain tapware lustre.

- Only use clear water to rinse and soft cotton cloth to dry.  
Never use abrasive products (such as cleaners, cloths, or paper) acidic detergent, harsh cleaner or soap.

✓ = Soft Cotton Cloth

✗ = Acid, Strong Detergent

In case of thick sediments proceeds as follows:

1. Clean the surface of your tapware with clear water and soft cotton cloth.
2. Use any of the following to remove the dirt:
  - Mild liquid detergent.
  - Clear liquid glass cleaner mixed according to the manufacturers directions.
  - Non-abrasive liquid polish.
3. After cleaning, rinse the tapware thoroughly again with clear water to remove the cleaner and dry it with a soft cotton cloth.

In case the water flow is reduced clean the aerator using instruction above.

