

Hinge Installation PN5120 + PN5700

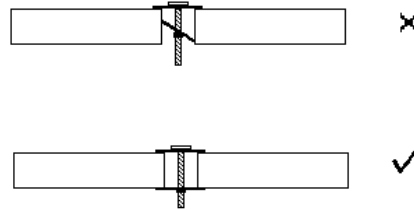

1. Make sure the clip and nut is placed at the bottom of the screw (as pictured left) and feed the hinge and screw set into the pan holes so that the clip will go the whole way through the porcelain and sit just below the bottom of the hole

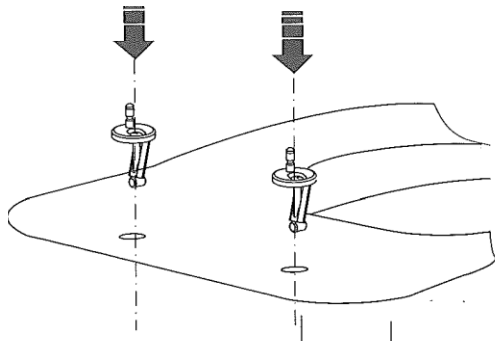

2. loosely screw the fittings so that you can adjust the position of the seat

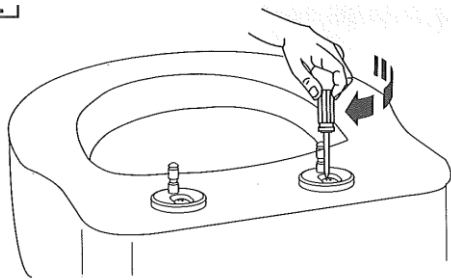

3. Mount the toilet seat and align it with the pan.

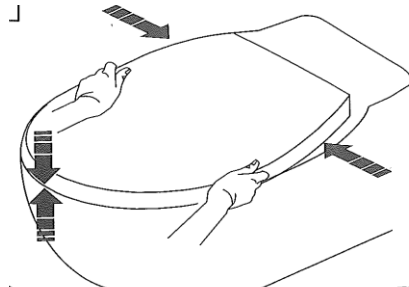
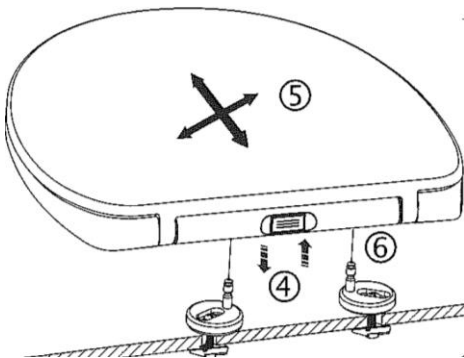

PARISI

4. Remove the toilet seat using the Quick Release button. Screw tight the bolt. It is very important that you tighten the screw until it can no longer be tightened. (clockwise)

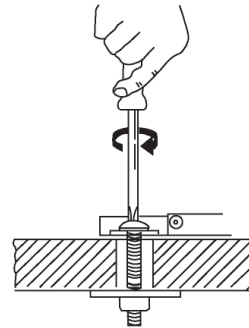
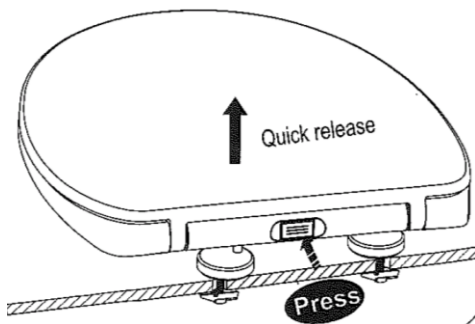

5. Put on the hinge covers and re-attach the seat

