

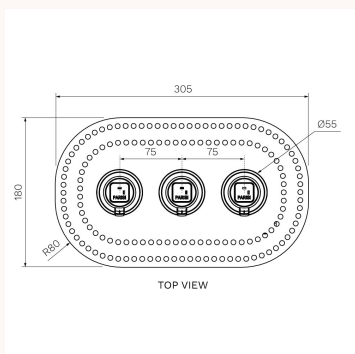

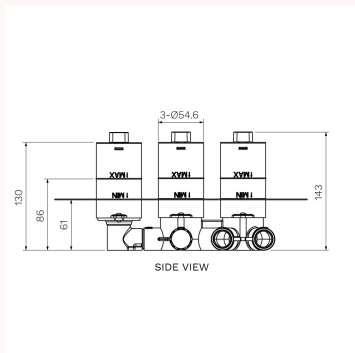

Incasso X4 Diverter Mixer Body (3-way) with Outlet

X4.04W-D3-A

Engineered for performance and built to last, the Incasso X4 redefines the standard for in-wall tapware bodies. Supporting leading waterproofing practices, designed for longevity, and engineered for ease of installation, it delivers confidence behind the wall. Its clever construction allows for effortless compatibility with PARISI's extensive collections, from styles to finishes, to complement your design and colour scheme. The Incasso X4 Diverter Mixer Body (3-way) is compatible with wall mixers featuring a diverter and outlet on plate. This space-saving design combines water control, outlet switching, and an integrated spout or hand shower on a single backplate. It is suited for shower-over-bath layouts, dual showers, or bath-and-shower combinations, delivering an all-in-one solution with flexible functionality and streamlined installation. [Wall Mixer with 3-way Diverter and Handshower Tapware](#)



Product type	Bathroom Tapware
Brand	PARISI
Range	Design
Designers	PARISI Design Team
WxDxH	240mm x 140mm x 75mm
Colour / Finish	 Brass
Material	Lead-Free DZR brass

Warranty	15 Year Warranty
Availability	Stocked Item
Features:	Water-Sealed Protective Cover. Water-Sealed Outlets. Tailored rubber gasket. Integrated spirit level. Universal Body. One-Piece Body Mounting System. Multiple outlet configurations. Smart Port System. High Performance Cartridge.
Installation Instructions:	Includes ½" male thread adaptor with cap. Recommended pressure: minimum 150 Kpa – maximum 500 Kpa.

PARISI

