

BASSINI

Toilet Suite

Back-to-Wall,
Rimless

The Harmony sanitaryware range will deliver the perfect solution for your bathroom



PRODUCT CODE

HARMONY11200 ●

FEATURES

Rim Configuration

Rimless

Waste Outlet

S or P Trap using universal connector

Inlet

Universal (top left or bottom inlet)

Seat

Soft-Close

Colour

White

Material

Vitreous China Pan & Cistern

Pan Set-Out

90-190mm

Weight

36Kg Pan, 15Kg Cistern

Flushing (Ltr)

4.4 Litres Full Flush,
3.0 Litres Half Flush,
3.2 Litres Average Flush

WELS Rating

4 Star

Australian Standards

AS1172.1-2014
AS1172.2-2014

Warranty

10 Years Pan & Cistern, 2 years Seat,
3 Years Valves, 1 Year Push Buttons

harmony®

PRODUCT DIMENSIONS

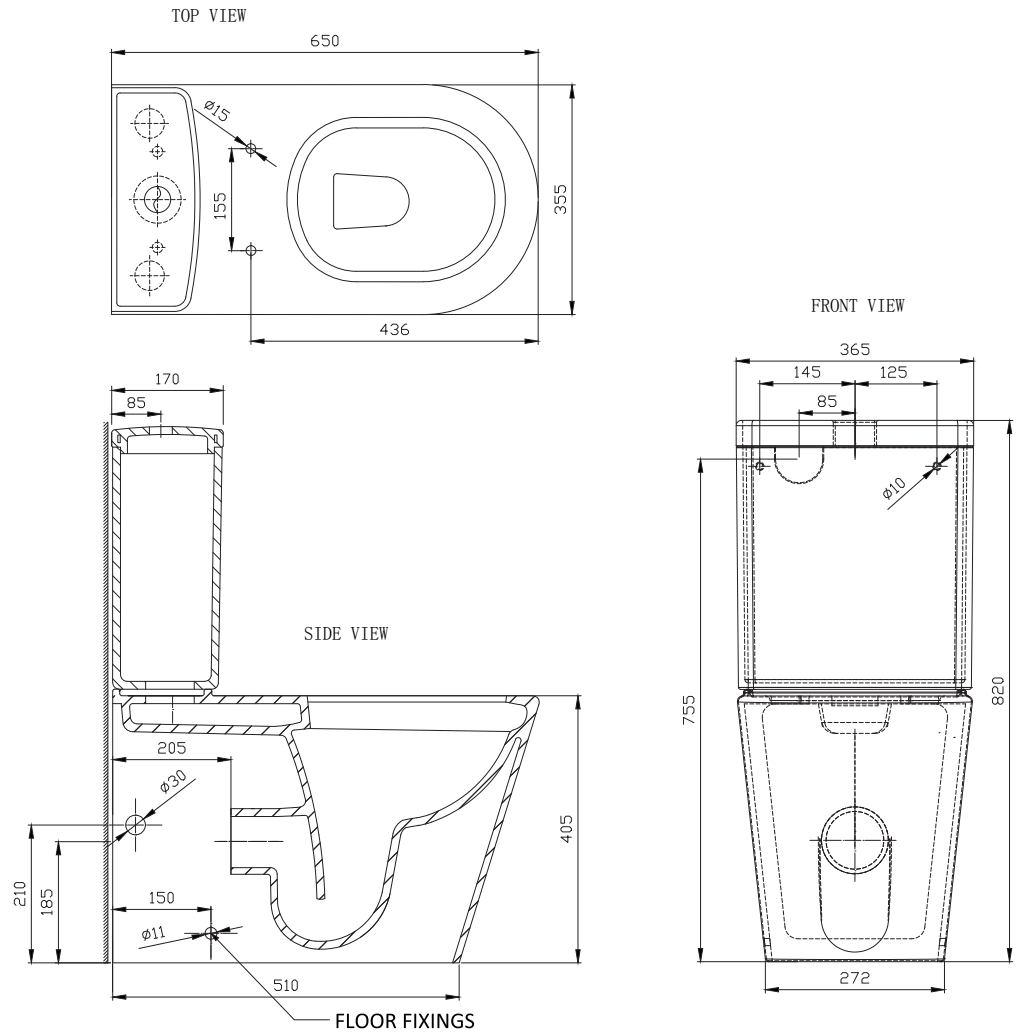

WELS RATING

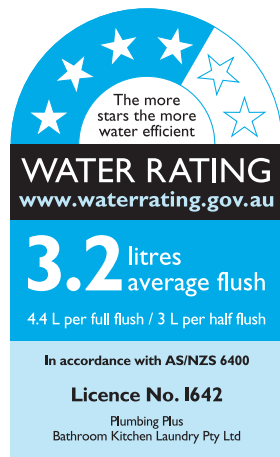

AUSTRALIAN STANDARDS



WaterMark

AS 1172.1 - AS 1172.2
Certificate No. 23263

DISCLAIMER

The installation of this toilet suite should be undertaken by a qualified and licensed plumber and in accordance with the National Plumbing Code AS/NZS 3500.2.2. Harmony sanitaryware products are designed to meet the appropriate Australian standards. Dimensions and set-outs contained are correct at the time of publication. However, neither the manufacturer nor the distributor takes responsibility for printing errors. The manufacturer and the distributor reserve the right to vary specifications or delete toilet suite models without prior notification. A failure to follow the installation instructions, or a failure to have the product installed by a licensed tradesperson, may void the product's warranty.

Version Date: 2022/04