



Soho Double Towel Rail 800mm

Product Image

Product Details



Code: TVA3362385 (Brushed Gold)
TVA3362380 (Brushed Nickel)
TVA3362361 (Chrome)
TVA3362390 (Gun Metal)
TVA3362395 (Matte Black)

Brand: Villeroy & Boch
Range: Soho
Warranty: 5 Years*
WELS: N/A

Additional Features

Technical Specification

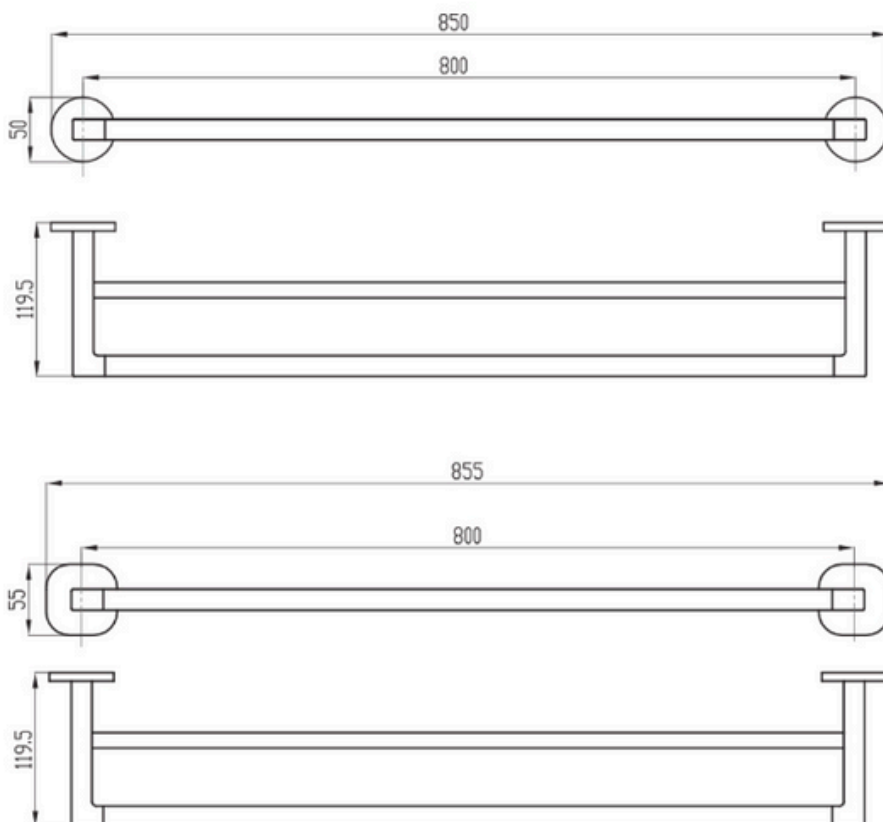

Additional Notes

- Round Flange included
- Soft Square Flange included

Installation

- Triple Fixing

*Please visit argentaust.com.au/warranty to view the full warranty

Note: All dimensions are in millimetres and are subject to normal manufacturing variations. Always use the physical product measurements for cut-outs and rough-ins as the technical details shown may differ from the actual product. Use acetic cured silicone sealant. Do not use epoxy type adhesives. Clean with damp cloth. Do not use abrasive cleaners, liquids or pastes.

